

# INSTRUCTION MANUAL

## REMOTE VFO MODEL 8010

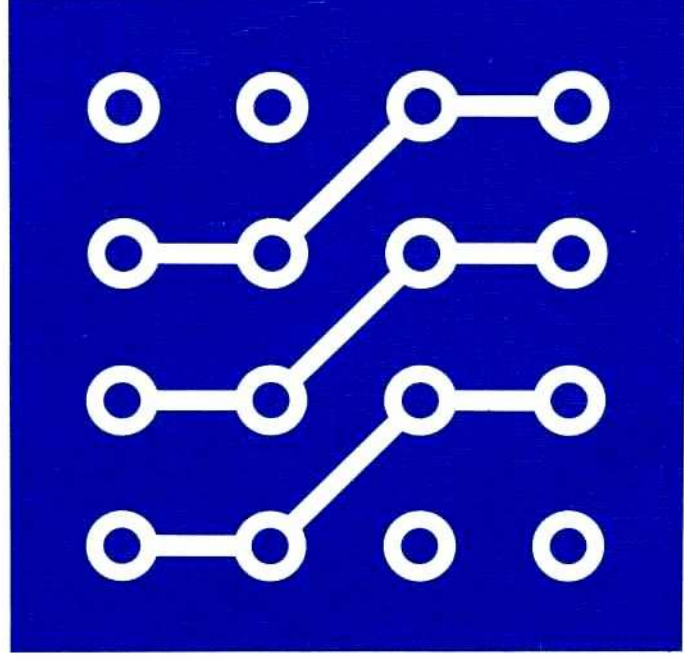

**uniden**

# REMOTE VFO MODEL 8010

(for SSB TRANSCEIVER MODEL 2020)



## TABLE OF CONTENTS

1 General Description .....	2
1-1 Features and Specifications .....	2
2 Control Functions .....	3
3 Operation .....	5
3-1 Interconnections .....	5
3-2 Operating Functions .....	5
3-3 The Dial Reading .....	6
3-4 Crystal Controlled Operation .....	6
4 Schematic Diagram .....	7

## 1. General Description

The 8010 is a remote VFO especially designed to match the communication SSB transceiver 2020.

By adapting this VFO, you can operate the transceiver either by its own internal VFO or by the external VFO depending on the operating situations.

The 8010 also has ten crystal-controlled fix channels providing you the convenience of operating on a certain spot frequency without being bothered to tune VFO dials.

Connections to the transceiver is done by a single cable, and the power is supplied from the transceiver.

### 1-1 Features and Specifications

The 8010 has adopted most of the unique features of the 2020. And especially its frequency read-out and a dual R.I.T. (Receiver Incremental Tuning) controls are original devices.

Main features are:

#### 1. Drift-free Oscillation

The 8010 has full 100 kHz frequency coverage from 9,138 to 9,038 kHz, assuring very stable and heat-free oscillation, helped by two-stage buffer amplifier and a clutched dial mechanism.

#### 2. Hybrid Dial Presentation

Like 2020, it is equipped with a digital and analog combination dial reading. 100 kHz order is displayed by a LED and below 100 kHz is shown by the drum dial. MHz order is read on the transceiver dial.

#### 3. Dual R.I.T. Control

This is also UNIDEN's original feature. Without changing transmitting frequency, you can change receiving frequencies for  $\pm 5$  kHz at the normal (WIDE) position, and for 1 kHz at the pull (NARROW) position of the control knob.

#### 4. Segment Switch Frequency Selection

The VFO adopts diode matrix circuit to select the program of the PLL oscillation. And every 100 kHz on each band is selected by pushing segment switch buttons.

#### 5. Crystal Controlled Operation

The VFO includes a crystal oscillation circuit to provide ten fixed channel operation within every 100 kHz segmentation and enables quick QSY to any determined frequency.

### Installation of an external speaker and a remote VFO (right)

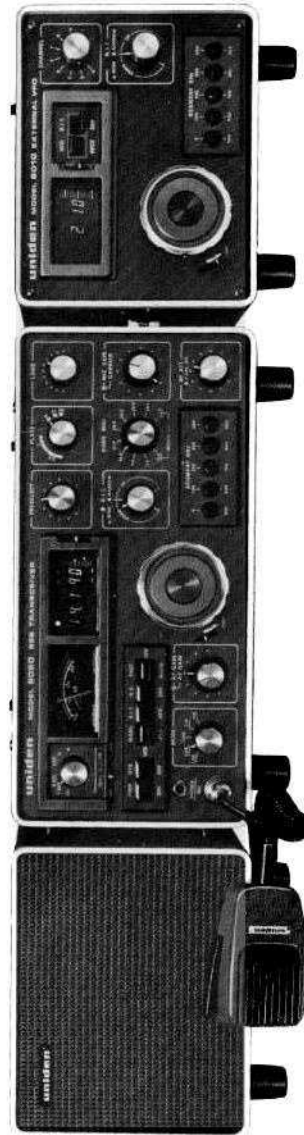

External Speaker model 8120

SSB Transceiver model 2020

Remote VFO model 8010

## Specifications

Output Frequency: 9,138 – 9,038 kHz

1 IC, 2 FETs, 3 Transistors, 32 Diodes  
 dimensions: 8-1/8"(W) x 6-1/2"(H) x 13-1/4"(D)

(205mm x 165mm x 333mm)

weight: Approx. 6.6 Lbs. (3kg)

## Note

When removing the VFO out of the package, please examine for visible defects and check all controls for normal operation, also check for internal damage, loose parts, etc. Make sure following items are in the package together with a VFO.

Connection cable . . . . . 1

Extra mounts and screws . . . . . 1 set

Extra mounts are to change the viewing angle of front panel in order to obtain the desirable operating position.

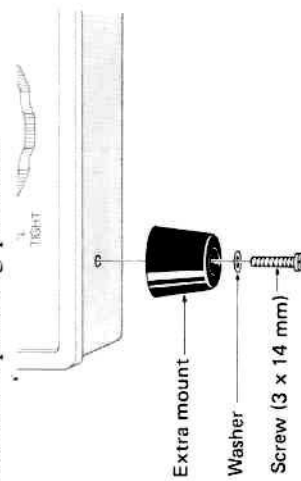

## 2. Control Functions

Functions of various controls on the front panel are;

**1. VFO-SPOT** A switch to change VFO and crystal oscillator (fixed channel oscillation)

**2. R.I.T.-OFF** When turned upwards (ON) the receiver incremental tuning circuit is actuated and a LED (A)

lights up to indicate the circuit is working.

**3. CHANNEL Selector** to change the crystal oscillation frequencies (channel A to J)

**4. LED (A)** Lights up when the R.I.T. switch (2) is turned on.

**5. R.I.T.** Receiver incremental tuning varies the receiving



frequency disregarding the transmitting frequency. At the normal (WIDE) position you can change the frequency 5 kHz to either side of the transmitting frequency. At the pull (NARROW) position 1 kHz to either side for fine tuning.

**6. SEGMENT kHz**  
100 kHz segmentation on every band is selected by these buttons. White and red figures of each button correspond to the figures of the band switch on the 2020 transceiver. '0' indicates the frequency coverage between 0 and 100 kHz, '100' indicates 100 to 200 kHz and so on.

**7. TIGHT**  
This lever tightens the tuning knob rotation as desired.

**8. TUNING KNOB**  
It changes VFO frequencies for full 100 kHz at a 4:1 ratio.

**9. DRUM DIAL**

It is controlled by the tuning knob (8) and indicates the dial reading below 100 kHz.

**10. LED Display**

100 kHz order is shown by this LED, which is selected by the segment switch.

**11. LED (B)**

This LED, when lit, indicates that the remote VFO is working upon transmission or reception

as is selected by the function switch on the transceiver. (see OPERATION)

**12. DIAL SET**

The exact frequency of the VFO is calibrated by the 2020 transceiver, and the dial pointer must be slid to the correct position upon calibration.

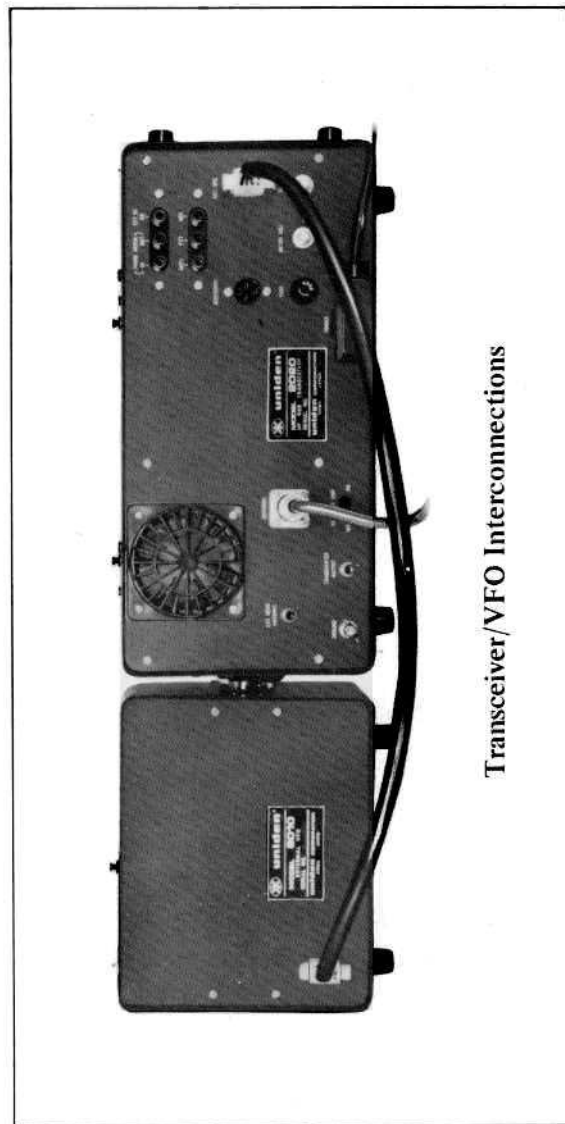

Transceiver/VFO Interconnections

## 3. Operation

### 3-1 Interconnections

The interconnections of this VFO and the transceiver is done by a single cable as is shown in the photo. Please make sure of their good contacts before going into actual operation.

### 3-2 Operating Functions

The 8010 has versatile operation by changing the function switch of the 2020 transceiver. Those functions are described in the drawing.

At positions INT./A/B, the remote VFO does not work at all. At T. EXT. position, the 8010 controls the transmitting frequency of the transceiver and at R.EXT. position only the receiving frequency. At EXT. position, both transmitting and receiving frequencies of the transceiver is controlled by the 8010 (VFO or fixed channel oscillator)

Those operating functions are indicated by LEDs on dials of the transceiver and the remote VFO.

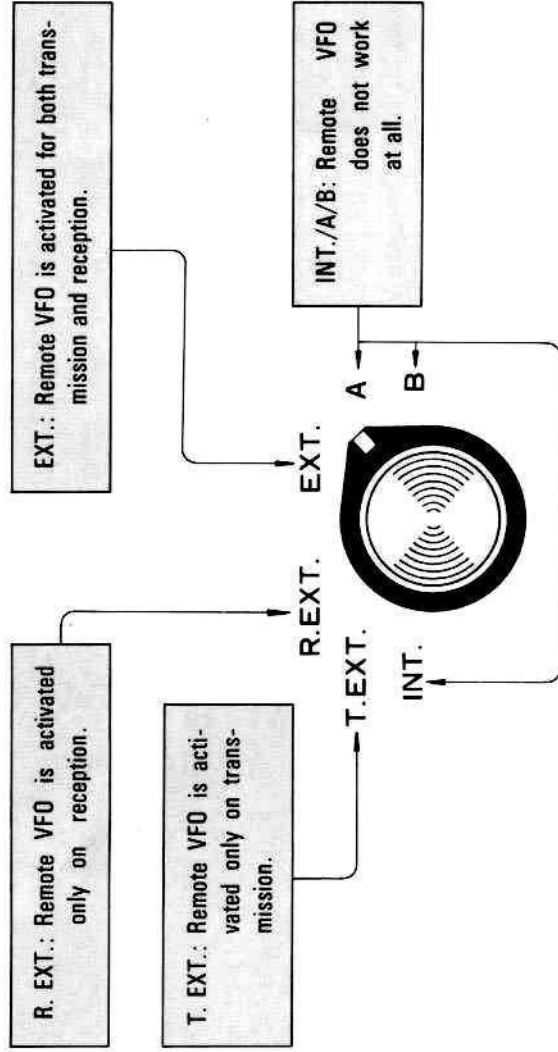

Function switch of the 2020

After selecting the mode of functions on the transceiver, follow the instruction of the CONTROL FUNCTIONS.

- 1 Operating band is selected on the main transceiver.
- 2 Select segment switch as desired.
- 3 Select either VFO or SPOT (crystal control) as desired.
- 4 Use R.I.T. when necessary.

**For the dial calibration of the 8010,** please refer to the instruction manual of the 2020 transceiver (4-3-1)

This remote VFO is especially valuable when you go into split frequency contacts. And it is also convenient when you sweep the operating band by fixing the transmitting frequency, or preset the frequency of a scheduled contact, etc.

### 3-3 The Dial Reading

As described before, the operating band is decided by the main transceiver. The dial reading of the transceiver remains the same even if the function switch is changed for the remote VFO operation.

When the function switch is changed to EXT. position, 100 kHz order must be decided by selecting segment switch of the remote VFO, and below 100 kHz is tuned by the remote VFO dial likewise.

The photo shows, when the remote VFO is actuated, the operating frequency is 14.230 MHz. (14 of 2020 and 230 of 8010)



The dial reading of the 2020

### 3-4 Crystal Controlled Operation

The crystal oscillator of the 8010 accepts ten crystals for channel A to J. Like 2020, crystal frequencies must fall within the VFO frequency range between 9,138 kHz and 9,038 kHz.

The crystal frequency (fx) for any desired operating frequency is calculated by the following formula;

$$f_x = 9,138 - fF \text{ (kHz)}$$

fF is any desired operating frequency within 100 kHz coverage regardless of operating bands.



Top window for installing crystals

By installing ten crystals, you can create 500 fixed frequencies combining the band and segment switches.

For further information, please refer to 2-4 of the 2020 instruction manual.

In ordering fixed channel crystals, please note the following oscillation circuit for reference.

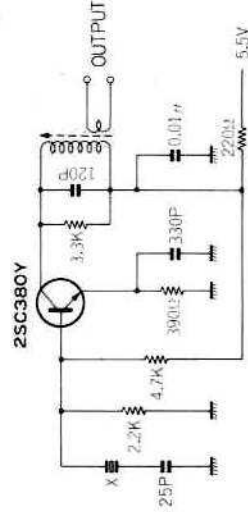

# 4. Schematic Diagram of the 8010

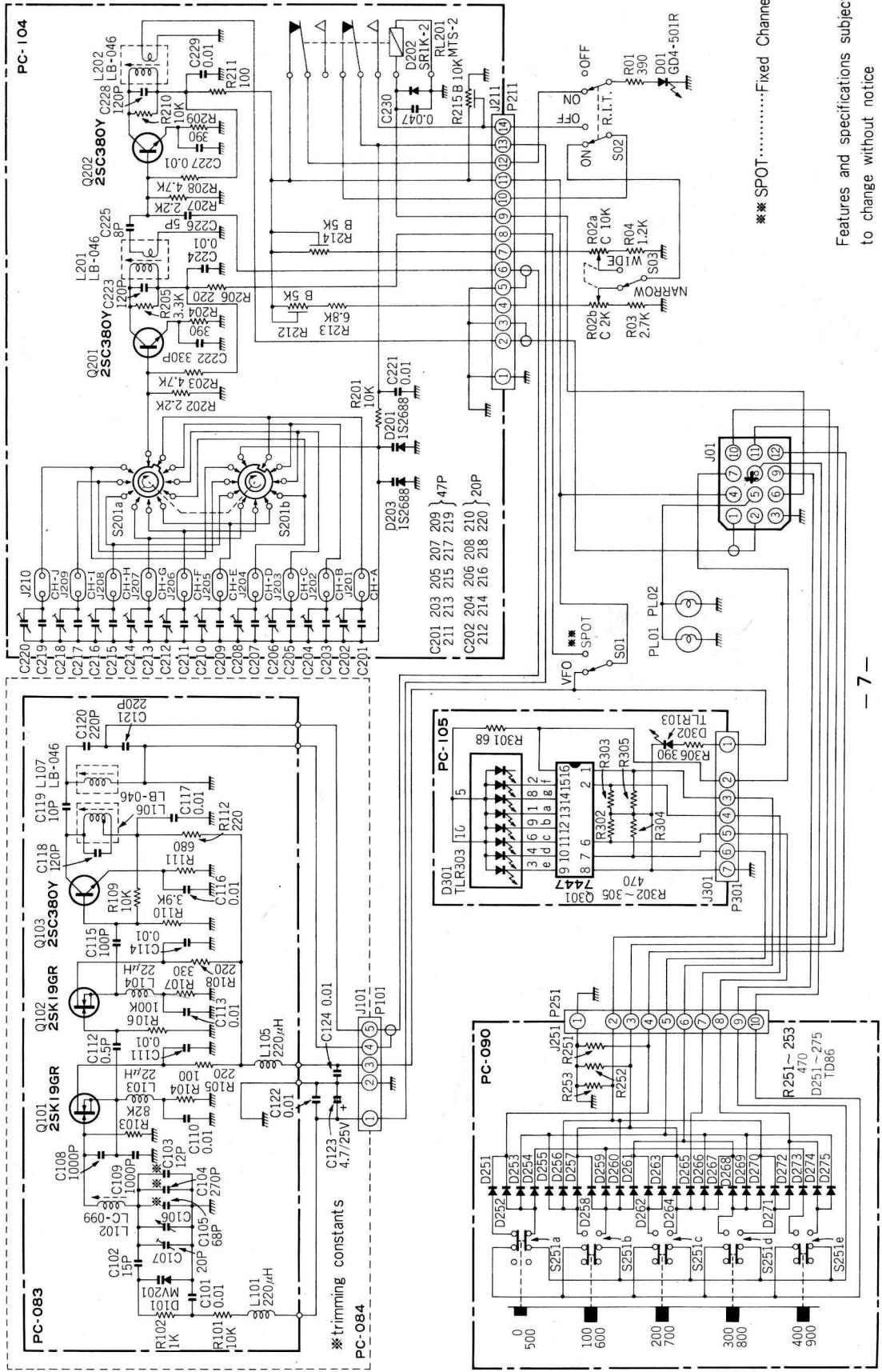

Features and specifications subject to change without notice





**uniden CORPORATION**

Tokyo, Japan

© 1975-8-1000  
uniden 8010-1

Printed in Japan

