

TRIO

2-METER BAND TRANSCEIVER

MODEL TR-2E

INSTALLATION MANUAL

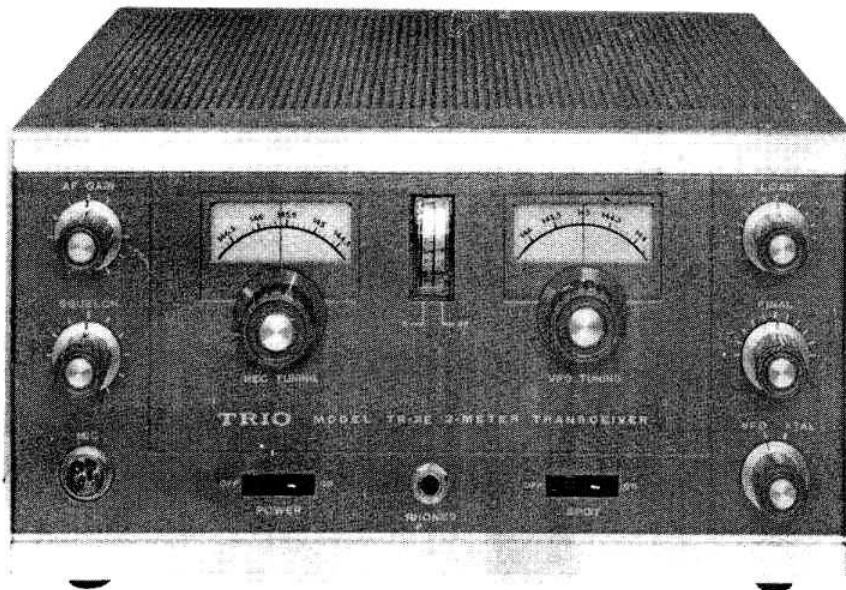

DISTRIBUTOR

SPECIAL FEATURES

Receiver Section

1. Triple Conversion Receiver.
2. 6CW4 Nuvistor Front End for good sensitivity and low noise level.
3. Internal Squelch Circuit to reduce inter-station noise.
4. Noise Limiter Circuit to eliminate pulse type interference.

Transmitter Section

1. Built-in VFO enables selection of any channel and assures efficient handling of QSO traffic.
2. Crystal holder circuit is built-in for crystal controlled transmission. Enables drift-free QSOs and fixed channel QSO scheduling.
3. The transmitter is easy to adjust. It requires operation of only two controls, both on the front panel, which adjust the final stage's output and matching circuits. This is made possible by the use of passband amplifiers in all the multiplier stages, which greatly simplifies changing frequency channels.
4. Highly efficient Final Stage. It requires only 20 to 24 watts input for full 9-10 watts RF Power output.
5. Simultaneous plate-screen modulation assures clean AM speech.

Transceiver

1. Push-to-Talk Microphone Switch accomplishes receiver transmitter switching for speedy message handling.
2. High impedance dynamic microphone supplied.
3. A pair of 6AQ5s operated as a Class A1 amplifier in a push-pull circuit provides dual service. It serves as the Power Amplifier for the Receiver, and also as a Modulator for the Transmitter. It provides good amplification with minimum distortion.
4. The S-Meter also provides dual service. It indicates incoming signal intensity during reception, and RF power output during transmission. Moreover, the flicker of the indicator during transmission serves as a modulation checker. The meter handles these functions automatically, and there is no need to bother with switching.
5. The unit incorporates a built-in power supply which enables AC operation from either 117 or 230 volt power sources. The power supply also has an internal DC Converter so that the unit can be operated from a 12V DC battery, enabling the transceiver to be used also for mobile applications.
6. Selection of power sources — AC; DC (-) Ground; DC (+) Ground — can be done simply by using the appropriate power cords which are supplied with the unit, and plugging their 12P Plug into the transceiver's Power Jack.

DESCRIPTION OF CIRCUIT

Please refer to schematic and block diagrams elsewhere in this manual. (Figure 1)

1. RF AMPLIFIER

A Nuvistor (6CW4) is used in a grounded-grid circuit. This circuit's input and output are fixed tuned according to the required passband characteristic, and no variable condenser is used. The grounded-grid principle assures low noise and stable amplification.

2. FIRST OSCILLATOR

The triode section of V3 6BL8 is used in a Vackar oscillator circuit to provide stable operation between the frequencies of 33.3 and 34.3 MHz.

3. FIRST OSCILLATOR BUFFER AMPLIFIER

The pentode section of V3 6BL8 is used as a buffer amplifier. It has the dual function of

amplifying the oscillator voltage, and also of assuring stable oscillation by preventing any change in oscillator frequency which may otherwise occur as a result of pulling effects from the following stage.

4. FREQUENCY TRIPLER

The local oscillator frequency of 33.3 to 34.3 MHz is multiplied to 100 to 103 MHz by a Silicon Diode 1S72 in a frequency tripler scheme. Advantage is taken of the nonlinear portion of the diode's characteristic to distort the input wave pattern and generate a number of high frequency harmonics at its output. The third harmonic is then selected for use by a resonant circuit.

5. FIRST MIXER

The Pentode section of V2 6BL8 is used for this purpose. The incoming signal of 144-148 MHz is mixed with the 100-103 MHz output of the Frequency Tripler and converted to the difference of these two frequencies, or 44-45 MHz, the 1st I.F. frequency.

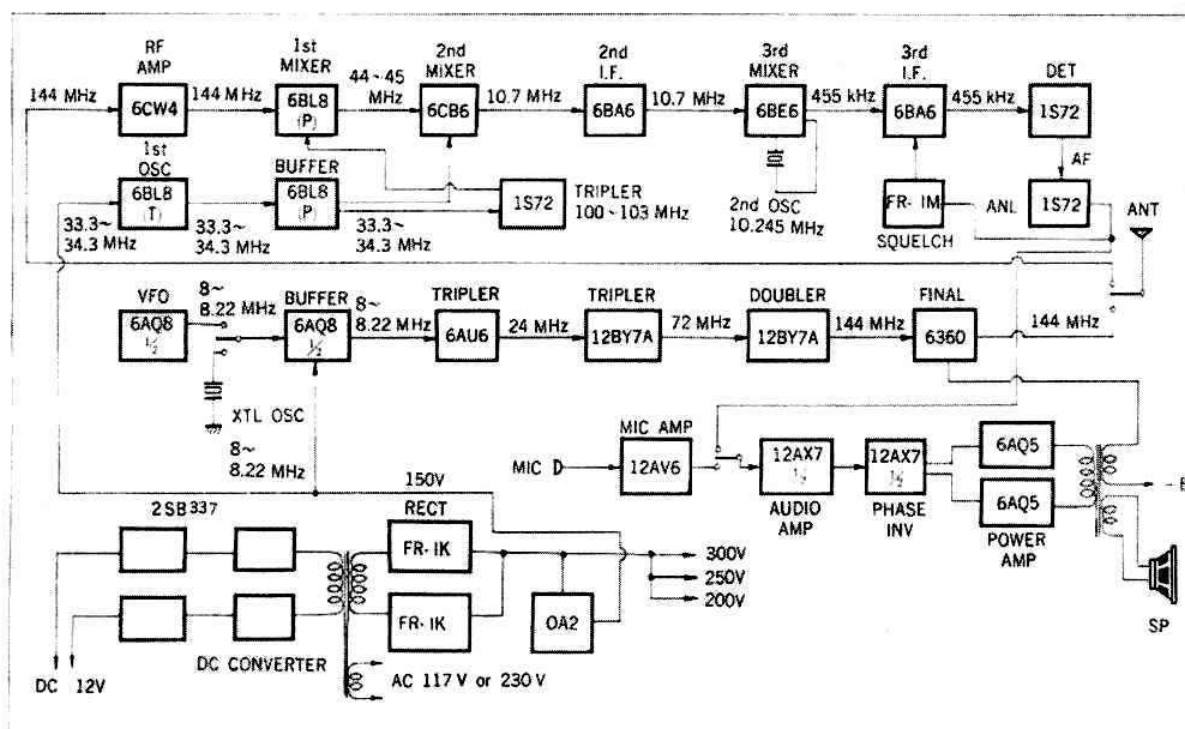

Figure 1 - Block Diagram

6. SECOND MIXER

This function is accomplished by a 6CB6. It converts the 44-45 MHz voltage from the First I.F. and the 33.3-34.3 MHz injected directly from the First Oscillator to obtain a 10.7 MHz 2nd I.F. Frequency voltage.

7. SECOND I.F. AMPLIFIER

A 6BA6 is used to amplify the 10.7 MHz 2nd I.F. signal.

8. THIRD MIXER

Frequency conversion to obtain the 455 kHz 3rd I.F. voltage is accomplished with a 6BE6 which is the Third Mixer. This tube is also used to resonate the crystal controlled Second Oscillator. The 3rd I.F. 455 kHz signal is obtained by mixing and converting the 10.7 MHz 2nd I.F. voltage which is fed to its G1 with the 10.245 MHz 2nd Oscillator signal produced by its screen grid section in a crystal oscillator circuit.

9. THIRD I.F. AMPLIFIER

This is accomplished by a 6BA6 amplifier, and a Squelch circuit is also inserted into this stage.

10. DETECTOR

A Silicon Diode 1S72 is utilized in a diode detector circuit.

11. NOISE LIMITER

A Silicon Diode 1S72 series-type noise limiter circuit is always in operation during receiving, to minimize pulse type interference such as automobile ignition noises which are constantly encountered in VHF ranges. Therefore, no provisions are made in this unit for an external ON-OFF noise limiter circuit switch.

12. SQUELCH CIRCUIT

Use of the Squelch circuit is very convenient during waiting periods as it can be adjusted, so that speaker response is nil during these times. When the signal resumes it can be heard without manipulating any controls. The circuit can also be adjusted to eliminate bothersome interstation noise during tuning. Squelching is achieved by varying the bias voltage of the I.F. amplifier tube V7 6BA6 and making it operate at varying cut-off points by injecting to its screen grid the audio noise which has been rectified by the squelch circuit diode. (FR-1M)

Variation of the cut-off point is achieved by adjusting the bias of this diode.

13. AUDIO AMPLIFIER

One section of V9a 12AX7 is used for audio amplification, while the other section V9b is used in a phase inverter circuit to excite the power amplifier stage, which is comprised of two 6AQ5s in a Class A1 push-pull power amplifier. Three watts of audio power are available at the 8 ohm speaker terminals extending from the secondary of the output transformer. The unit does not contain a speaker, which must be connected externally to the speaker terminals. Any speaker with an impedance of 4 to 16 ohms may be connected here.

This circuit is also used during transmission as a Modulator.

14. VFO

The Variable Frequency Oscillator in the transmitter section is a very convenient feature of this transceiver. It enables varying the transmitter frequency to any desired channel within the amateur band of this transceiver. Stable oscillation is achieved in the V12a half section of the 6AQ8 to produce an 8 - 8.222 MHz fundamental frequency VFO voltage. This voltage is introduced to the second half section of this tube, V12b, which is used in a Buffer amplifier circuit. This buffer stage prevents the following stage from inducing pulling effects on the oscillator, and changing the oscillator frequency.

At the same time, a crystal switch-in circuit is incorporated in this stage to enable crystal controlled transmitter operation.

Crystals of 8 to 8.22 MHz may be used for this purpose.

15. 24 MHz MULTIPLIER STAGE

This circuit triples the fundamental frequency of 8 MHz to 24 MHz by utilizing V13 6AU6 in a Class C operation. Its plate circuit is tuned to the 24 MHz passband width by the Plate Coil L16 and TC-5 and TC-6. Moreover, passband amplifier design considerations are incorporated in this and the succeeding multiplier stages. The passband width for this stage is 24 MHz to 24.666 MHz.

16. 72 MHz MULTIPLIER STAGE

This circuit triples the 24 MHz voltage fed into it from the previous stage to between 72 MHz and 74 MHz. It utilizes V14 12BY7A in exactly the same manner as the 24 MHz multiplier stage.

17. 144 MHz MULTIPLIER CIRCUIT

Whereas the induced frequencies of the previous multiplier stages were tripled, it is doubled in this circuit to between 144 MHz and 148 MHz. Frequency multiplication is achieved in the same manner, except that whereas the plate outputs were parallel-tuned in the previous multiplier stages, series-tuning is adopted here. The reason for this is that stray capacitive effects can no longer be ignored at the VHF ranges above 100 MHz, and parallel-tuning makes it very difficult to obtain the desired output because of the tuned circuit's very low inductance and resultant low Q factor. On the other hand, an effective output voltage can be obtained with series-tuning which reduces stray capacitance, and permits increasing the inductance and adopting a higher Q factor.

The tuned circuit of the secondary supplies the necessary voltage to the push-pull amplifier of the final stage. In other words, it supplies the necessary excitation voltages to the two push-pull input grids of the final stage so that they are 180 degrees out of phase.

18. FINAL AMPLIFIER

This function is carried out by a 6360, a two-in-one, dual beam, VHF-purpose tube. This tube is used in a pushpull circuit, operated as a Class C amplifier. The circuit is self-biased by

utilizing the voltage drop caused by current flow through the resistor connected between the grid-side midpoint and ground.

RF power output created in the tuned circuit of the plate side is coupled through a Link Coil and fed to the antenna after matching is accomplished by L20 and VC4 and VC5.

VC-3 in the plate resonance circuit is a semi-variable capacitor which should be adjusted for maximum RF output under load conditions.

During regular operation of the transmitter it is only necessary to adjust VC4 and VC5 for antenna matching. These controls are readily available on the front panel.

19. MODULATOR

The microphone output level is fed to the 12AV6 Speech Amplifier, the output of which is injected to the input of the receiver section's audio amplifier. The operation of this section has already been explained. The voltage obtained at the 3.8 K ohm secondary winding of the audio Power Output Transformer is then supplied to the final stage of the transmitter as a modulating voltage for plate and screen grid modulation.

The power output is 10 watts.

20. SEND-RECEIVE SWITCHING

One touch of the push-to-talk microphone switch enables receiver-transmitter switching. The microphone switch activates the ON-OFF relays.

21. CALIBRATOR CIRCUIT

This circuit enables accurate setting of the transmitter frequency to the identical frequency of the station being received. When it is desired to do this, the SPOT switch is turned to ON.

Only the VFO and the 24 MHz Multiplier stages on the transmitter side will then be operating. The VFO dial can now be turned so that zero-beat is obtained with the incoming signal, which results in setting the transmitter frequency accurately against that of the incoming signal.

22. S-METER CIRCUIT

During transmission the meter indicates RF power output. This is achieved by tapping a part of the voltage at ANT output through C74 1P, rectifying it, and measuring the rectified current flow.

During receiving operations the S-meter is placed in a bridge circuit formed by the plate current of the I.F. tube V5 6BA6, with that of the B+ supply circuits. S-meter function modes are automatically switched, requiring no hand switching.

During transmission, the flicker of the S-meter indicator also provides a general check on modulation.

23. POWER SUPPLY

The same B+ power supply circuit (after the secondary of the power transformer) is used for both AC and DC power source operations.

In the case of AC power source operation, the transceiver can be used from either AC 117V or 230V sources by switching to match the source available. Two sets of 117V AC primary windings are available, with the built-in AC Power Selector Switch hooking them in series for 230V sources, and in parallel for 117V sources.

In the case of DC 12V battery operation, a built-in DC Converter comprised of 4 Power Transistors and the Power Transformer in a push-pull conversion circuit goes into operation, producing a 50 Hz voltage. This voltage is stepped up at the secondary of the Power

Transformer and then rectified, producing a high DC voltage for B supply. Full wave rectification assuring a minimum of ripple is accomplished by utilizing a Silicon Diode Rectifier circuit. Voltage supply is divided at 300V, 250V, and 200V. 300V is supplied to the Power Amplifier and the Transmitter's Final Amplifier, 250V is supplied to the remaining B+ requirements of the transmitter, and 200V to the remaining B+ requirements of the receiver.

Furthermore, a part of the voltage is supplied to the VFO after it has been regulated to a constant value by V17 OA2/VR-150. This regulated power supply assures good frequency stability of the transmitted signal.

Heater and Relay Power requirements are made available as follows:

During AC operation, the heaters are supplied directly from the AC 12V winding of the Power Transformer, while the relay is supplied with a 12V DC current which has been rectified.

During DC operation, the heaters and relay are supplied directly from the 12V battery.

AC-DC Source Switching — The convenient 12P type connector is used to switch from AC-DC operation or vice versa.

For AC operation a special AC line cord is supplied, insertion of which into the Power Jack is all that is necessary.

For DC operation, a plug has been supplied to enable connections either for (+) Grounding or (-) Grounding in order that the transceiver can also be operated in an automobile by using its battery. Please refer to detailed diagram.

CONTROLS AND THEIR FUNCTIONS (See Photo 1)

- (1) **AF GAIN** — Receiver Volume Control. Turn clockwise to increase sound level.
- (2) **SQUELCH** — Squelch control. Turn clockwise to increase squelch action (Reduce inter-station noise)
- (3) **MIC** — Microphone Jack. Insert plug. Tighten lock.
- (4) **REC TUNING** — Receiver Tuning Dial.
- (5) **VFO TUNING** — VFO Tuning Dial. It sets the transmitter frequency.
- (6) **LOAD** — Antenna Impedance Matching Control. It is the variable capacitor at the output of the pi-network which is in the plate circuit of the transmitter's final stage.
- (7) **FINAL** — It is the variable capacitor at the input side of the Transmitter's output matching network.

Controls (6) and (7) should be adjusted back and forth until maximum deflection of the RF OUT meter is obtained.

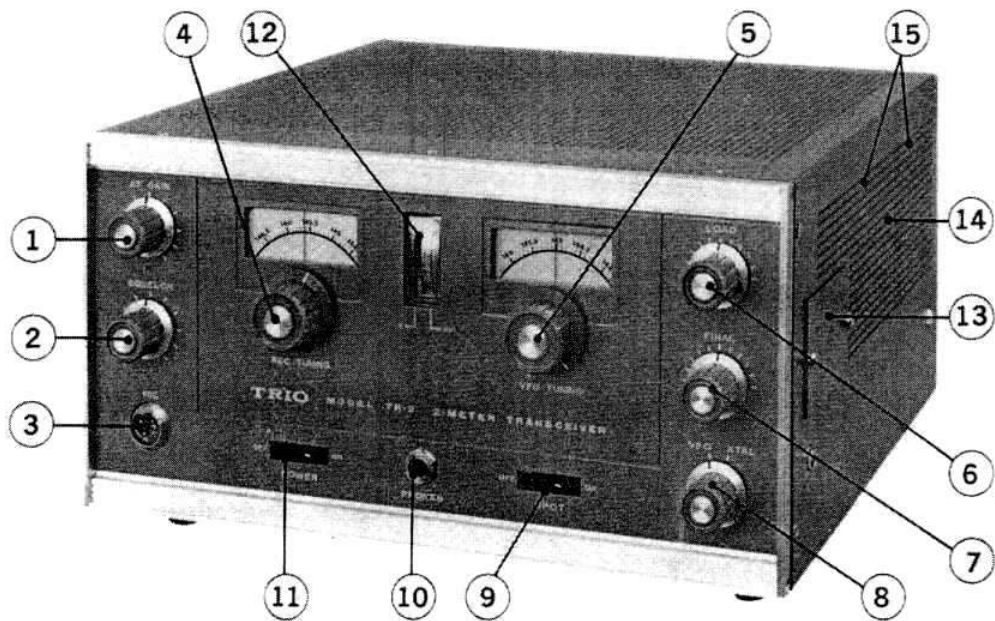

▲ Photo 1

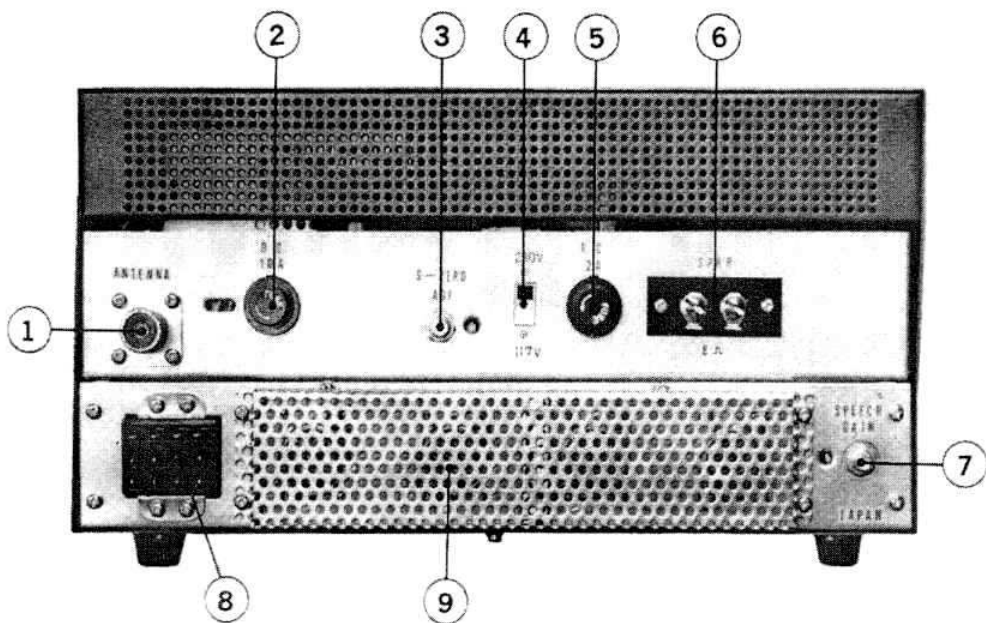

▲ Photo 2

- (8) **VFO-XTAL** — This Switch determines the method of controlling the transmitter frequency — variable frequency control at VFO position, and crystal-controlled at XTAL position if a crystal is inserted into the crystal holder at the side of the unit.
- (9) **SPOT** — Calibration Purpose Switch. At ON position, this switch enables setting the transmitter frequency exactly to that of an incoming signal merely by turning the VFO dial and tuning for zero-beat.

Always switch SPOT to OFF when transmitting. Otherwise, no signals will be radiated.

- (10) **PHONES** — Phone Jack. Plug in the head phones here for private listening.
- (11) **POWER** — Power Switch. This is used both for AC or DC power source operations.
- (12) **S-METER** — This indicates incoming signal strength during reception, and RF power output during transmission.

DESCRIPTION OF REAR CHASSIS

CONTROLS & TERMINALS (See Photo 2)

- (1) **ANTENNA** — M type connector is used here. It serves both the receiver and the transmitter.
- (2) **DC FUSE HOLDER** — Insert a 15 ampere fuse here. Although this is to fuse the DC 12V supply, a fuse must be inserted even if the transceiver is to be operated from an AC power source.
- (3) **S-ZERO ADJ** — S-Meter zero level control.
- (4) **230V 117V SWITCH** — AC Power Select Switch. Switch to the AC power voltage available in your district.
- (5) **AC 2A FUSE HOLDER** — Insert 2 ampere fuse here.
- (6) **SPKR** — Speaker Connecting Terminals. Impedance is 8 ohms here, but any 4 to 16 ohm speaker may be connected.
- (7) **SPEECH GAIN** — Modulator Gain Adjustment. Clockwise rotation increases modulation.
- (8) **PWR** — Power Source Connection Jack. It is an AC-DC dual purpose jack. Insert a 12P Plug here for AC: 117V or 230V; DC:12V (-) Grounding; and DC:12V (+) Grounding. Connection to any one of these three sources can be made with the Power Source Connection Plug which is supplied. Refer to Schematic Diagram for plug connection details.
- (9) **Transistor Protection Screen Cover.**

SIDE CHASSIS DESCRIPTION (See Photo 1)

- (13) **Crystal Holder Compartment Cover**

The crystal holder socket is available under this cover. Insert a FT-243 type crystal with a frequency between 8 to 8.222 MHz if it is desired to operate a crystal controlled transmitter.

- (14) **Final Stage Tank Capacitor (VC-3) Adjustment Hole**

A notched shaft head of a capacitor can be

seen through this hole. This control has already been adjusted before shipment from the factory. However, it can be further adjusted with a screwdriver if it is desired to make an optimum adjustment at your working frequency.

- (15) **Car Mounting Taps**

Tap holes are available here, and also on the opposite side of the chassis enclosure to facilitate angle mounting for car installations.

OPERATING INSTRUCTIONS

1). AC POWER SOURCE OPERATION

Insert the 12P Plug of the AC Power Cord into the PWR Jack at the chassis rear. Next switch the 230V-117V Switch, also at the chassis rear, to correspond to the line voltage available in your district. Make sure this is done BEFORE inserting the AC cord plug into an AC outlet.

2). DC POWER SOURCE OPERATION

Insert the 12P Plug of the DC Power Cord into the PWR Jack at the chassis rear. The other end of this cord can now be connected to a 12V DC battery. (+), (-) polarity connections must be carefully made as improper connections will damage the Transistors in the DC Converter. RED is plus (+). Blue is (-). (See Figure 2)

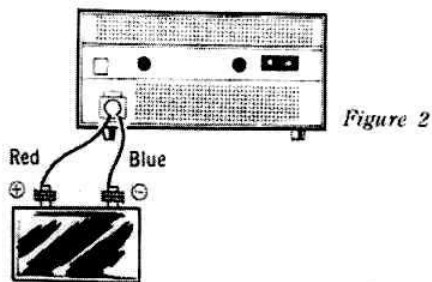

- 3). After completing either above steps 1 or 2, connect the speaker to the SPKR terminal. If private listening is desired, plug the headphones into the PHONE Jack on the front panel. Now plug the Microphone into the MIC Jack.
- 4). Connect the Antenna line to the ANTENNA Jack at the chassis rear. Antenna input impedance here is 50 ohms unbalanced, so that a 50 to 75 ohm antenna should be connected. The transceiver is now ready for operation.
- 5). Turn the POWER switch to ON and advance the AF GAIN control. After a short while, speaker response will show that the receiver is operating.

Tune in a station by slowly turning the REC TUNING dial. Re-orient the antenna if no station can be picked up.

S-Meter Zero Setting — The S-Meter has been zero-set at the factory before shipment. If, however, it requires resetting, it can be done easily as follows.

- (1) Set REC TUNING dial to around 145 MHz.
- (2) Remove the antenna. Now adjust the S-ZERO ADJ control at the rear of the chassis so that the S-Meter reads zero.

6). TRANSMITTER OPERATION

With the receiver in operation, set XTAL-VFO to VFO position, and then adjust VFO TUNING dial to the desired transmitter operating frequency. If crystal-controlled transmission is desired, insert a crystal into the crystal holder socket, and switch XTAL-VFO to XTAL position.

Now as the REC dial is turned, a point will be reached where loudspeaker response suddenly disappears and the S-Meter indicator will swing to around S9. This is the point where the transmitter frequency and the receiver's tuned frequency are identical.

7). SETTING THE TRANSMITTER TO THE INCOMING SIGNAL FREQUENCY

Leave the REC dial set at the position where an incoming station signal is heard. Switch SPOT to ON and VFO-XTAL to VFO. Now as the VFO TUNING dial is turned, a point will be reached where a beat response will be obtained.

Fine tuning in this vicinity will result in variation of the response levels, which indicate two points of peak response. There will be a point of zero-beat, or no response, midway between the two response peaks. At this zero-beat point, the transmitter will be set exactly at the frequency of the incoming received signal. (See Figure 3)

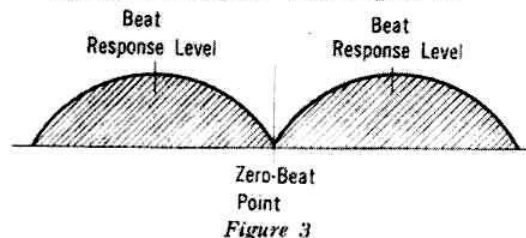

8). ADJUSTING THE TRANSMITTER

Now you are almost ready to go on the air. Be sure to switch SPOT to OFF. No radiation will be obtained at ON.

Set LOAD and FINAL controls around their midpoint range, and press the Push-to-Talk Switch on the microphone while watching the S-Meter. This action switches the Transceiver from Receiving to Transmitting operation. If FINAL is turned quickly, a meter swing will be observed. Adjust FINAL for maximum deflection. Now manipulate LOAD control in the same manner, and adjust this also for maximum meter deflection. Adjust FINAL and LOAD back and forth, more precisely now, so that maximum meter deflection is obtained.

9). GOING ON THE AIR

This completes the transmitter adjustments and you are now ready to go on the air. Notice the meter flicker as you speak into the microphone. This indicates that your transmitted carrier signal is being modulated. If a flicker movement is not noticeable, advance the SPEECH GAIN control at the rear of the chassis in a clockwise direction, until this modulation indication is obtained.

Your transmitter and receiver are now ready for operation, and you may commence CQing with the confidence that you have a good, dependable rig. We wish you many happy QSOs!

TROUBLE-SHOOTING

RECEIVER SECTION

If and when trouble is encountered, a block by block check as follows is recommended for effective and efficient troubleshooting.

1. CHECK AGAIN

Make sure you have read this manual thoroughly and that all switches and controls have been set correctly and that the necessary connections have been made properly.

2. AUDIO SECTION

Push mike switch to TALK and place the transmitter in operation. Check modulation by watching S-meter fluctuations as you talk. Fluctuations will indicate that the audio section is operating normally. Check speakers, phones, and connections if receiver response is still not obtained. In case the modulation test indicates the audio section is not working properly, check voltages, output transformer, earphone jack etc., in the audio circuits.

3. 3rd I.F. and DETECTOR

Inject 455 kHz AM signal to G3 of V6 6BE6 (Pin 7). If speaker response is obtained, the stages from that point on are operating normally.

4. 2ND I.F. and 3RD MIXER

Inject 10.7 MHz AM signal from a Test Oscillator to G1 (pin 1) of V4 6CB6. If speaker response is obtained, the stages after this point are operating normally. If not, check voltages, and parts in this stage, especially the crystal (10.245 MHz) across the Screen Grid and G1 of V6 6BE6. To do this, insert a sensitive current meter (200-300 microampere) between the 47 K ohm resistor R28 and the chassis. Also ground the junction of the XTAL and C41 0.01 microfarad capacitor at the screen grid side of the XTAL. When this ground connection is made, the current flow through the meter should drop which will indicate that the crystal is oscillating normally. Absence of current, or no change in current flow when this junction is grounded, indicates that the crystal is defective and must be replaced.

5. 1ST OSCILLATOR

Remove the Shield Case Cover from the Oscillator-Buffer block. Locate the Plate Tuning Coil L8 of the Buffer Amplifier tube V3b 6BL8P and place an Absorption Wavemeter or a Grid Dip Meter close to it. Meter deflection between 33 and 34 MHz indicates no trouble from this point back. If no meter movement is obtained, check voltages and parts.

Whether the First Oscillator V3 6BL8T is oscillating or not can be checked as follows. Insert a 10 to 50 m ampere range milliammeter into the plate lead between plate resistor R10 and the B + supply. The tube will be oscillating if this meter fluctuates when G1 (Pin 9) is then alternately grounded and released.

6. RF, FIRST AND SECOND MIXER STAGES

Check voltages and parts for these stages. A VHF Oscillator is necessary to make a more thorough check. Also refer to the section outlining "Adjustment Procedure."

TRANSMITTER SECTION

1. IN CASE OF NON-RADIATION

Press Push-to-Talk button and switch unit to transmitter operation after inserting a 10 m ampere range milliammeter in the lead between the 15 K ohm Grid Leak of V16 6360 and the chassis. The meter's (-) lead should be connected to the grid leak and the (+) lead to the chassis.

A current of less than 3 milliamperes indicates insufficient exciter voltage. If, however, there is no current indication, switch unit off immediately, as there is a possibility of damaging the 6360 tube if there is no grid current. In such a case, the 6360 can be protected by removing B supply from the screen grids as this will stop plate current flow. Now the grid current test can be made again, as it should be available even if the plate current flow is stopped.

If grid current is available and the transmitter does not radiate power, check the B+ supply voltage and the 6360 tube.

2. GRID VOLTAGE TEST

An insufficient exciter voltage as indicated by a grid current of less than 3 milliamperes would mean that trouble must be looked for in the preceding stage or stages. Whether these stages are operating properly or not can be ascertained by checking the minus grid voltages, which should be as follows:

- 70 V to - 120 V between Grid and chassis of V15 12BY7.

- 25 V to - 40 V between Grid and chassis of V14 12BY7.

If voltage checks do not show these readings, look for trouble in their respective preceding stage.

3. VFO OSCILLATOR CHECK

To check whether the VFO Oscillator is oscillating, place a voltmeter across the grid of V13 6AU6 and the chassis. Now with the VFO-XTAL switch at XTAL, a meter swing will indicate that the XTAL oscillator circuit is working. A swing of the meter when the switch is placed in VFO position will indicate that the VFO Oscillator is working properly.

4. CAUTION

A. Always cut off the power supply when inserting or removing tubes, because the heaters of two or three tubes are connected in series.

B. Always insert a dummy load across the ANT Connector when testing or adjusting the transmitter in order to prevent unnecessary radiation.

ALIGNMENT INSTRUCTIONS

This transceiver has been aligned at the factory. It requires no further alignment, unless perhaps when major parts replacements are made. Alignment, however, should not be attempted without the proper test equipment. If proper test equipment is available, the following instructions will facilitate alignment.

1. RECEIVER SECTION

1.1 Alignment of the 3rd I.F. Transformer (455 kHz)

Test Equipment: Sweep Generator, Oscilloscope.

Step (a). Connect the Sweep Generator output cable to the receiver detector output [junction of R56 (47 Kohm) and R37 (1 Megohm); C52 (200P)].

Step (b). Connect the vertical input leads of the oscilloscope across G1 of V7 6BA6 (Pin 1) and the receiver's chassis.

Step (c). The characteristic curve of the I.F. transformer will appear on the scope screen as the sweep output level is increased. Adjust both the top and bottom slugs of L13 so that maximum response is obtained at 455 kHz. Next, leave the audio lead as is, and connect the RF lead to G3 of V6 6BE6 (pin 7). Adjust the top and bottom slugs of the IFT (L12) for maximum response. Repeat the slug adjustments of L13 and L12 once again to obtain good characteristic response as shown below. (See Figure 4)

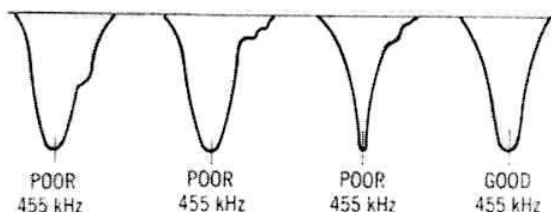

Figure 4

1.2 Alignment of the 2nd I.F. (10.7 MHz)

Test Equipment — AM Signal Generator capable of producing 10.7 MHz signal; 8 ohm Dummy Resistor, Oscilloscope or Audio VTVM.

Step (a) Connect the dummy load and the VTVM or oscilloscope across the speaker terminals.

Step (b). Connect the output of the Signal Generator to G1 of V4 6CB6 (pin 1). Insert a 10.7 MHz signal, modulated 30% by a 1000 Hz sine wave.

Step (c). Adjust the primary and secondary slugs of the IFT (L10, L11) alternately for maximum audio output response.

Step (d). After completing this 10.7 MHz alignment, the 455 kHz alignment as outlined above should be repeated for maximum response. This is to compensate for any frequency discrepancy of the 2nd Crystal Oscillator.

1.3 Alignment of the First Oscillator

Test Equipment — Frequency Counter, Wave Meter or Crystal Calibrated Oscillator; RF Vacuum Tube Voltmeter.

Step (a). Connect the Frequency Counter to the plate side of L8 through a capacitor of about 5PF. Set the receiver's tuning dial to 144 MHz, and adjust the slug of the Oscillator Coil so that its resonant frequency is 33.3 MHz.

Next set the receiver dial to 148 MHz and adjust the Piston Trimmer (TC-2) so that the Oscillator frequency becomes 34.3 MHz. Repeat the above steps several times. Frequency values may be approximate, as they are not too critical at this stage.

Step (b). Connect the RF VTVM to the plate side of L8 through a capacitor of about 5 PF. Set the receiver dial to 146 MHz and adjust the slug of L8 so that maximum Oscillator output is obtained.

Step (c). Repeat the adjustments outlined under Step (a), but this time connect the Frequency Counter to the output side of condenser C17 (1PF). Special care must be taken to make an accurate adjustment this time as the circuit's passband and dial calibration will be determined by this adjustment.

1.4 Alignment of the 1st I.F. (44-45 MHz)

Test Equipment: AM Signal Generator capable of producing a 44 to 45 MHz signal; 8 ohm Dummy resistor; Oscilloscope or VTVM.

Step (a). Connect the Signal Generator to G1 of V2 6BL8 (pin 2) and the dummy resistor and oscilloscope or VTVM across the speaker terminals.

Step (b). Set the receiver dial to 144 MHz and tune the Signal Generator to obtain maximum audio output (44 MHz). Now adjust the slugs of L5 and L6 alternately for maximum audio response. Next set the dial to 148 MHz and the Signal Generator to 45 MHz and observe the audio response level. Now adjust L5 and L6 so that about the same response level is obtained as before at 44 MHz. In addition, the band width is determined by adjusting the length of the vinyl lead of C14 0.5P.

1.5 RF Alignment

Test Equipment: AM Signal Generator capable of producing 144 to 148 MHz signal; 8 ohm dummy resistor; oscilloscope or VTVM.

Step (a). Connect the Signal Generator to the Antenna Jack and the dummy resistor, oscilloscope or VTVM across the speaker terminals.

Step (b). Set the receiver dial to 145.5 MHz and insert a 145.5 MHz signal modulated 30% by a 1000 Hz audio sine wave. Adjust signal generator level so that a 50 mW audio output is obtained.

Step (c). Adjust TC-1 so that maximum audio output is obtained, and then TC-3 also for maximum

response. Now adjust the slugs of L3 and L4 alternately for maximum response.

Step (d). It is recommended that the audio output be held down to around 50 mW when making these adjustments. This will facilitate alignment work. The signal generator output level can be started high at about 40 dB, and gradually lowered as receiver sensitivity increases. At the point of perfect alignment, S/N will equal 10 dB when 6 dB equals 2 microvolts.

After completing this step, make response checks at 1 MHz intervals from 144 MHz up to 148 MHz.

2. TRANSMITTER SECTION

2.1 VFO Alignment

Test Equipment — Frequency Counter or Wave Meter; RF VTVM.

Step (a). Couple the Frequency Counter through a 10 PF capacitor to G1 of V13 6AU6 (Pin 1). Now set VFO-XTAL Switch to VFO and the SPOT switch to ON.

Step (b). Set the VFO Tuning Dial to 144 MHz and adjust the slug of the VFO Oscillator Coil L14 so that the oscillation frequency is 8 MHz. Now set the VFO dial to 148 MHz and adjust the Piston Trimmer (TC-4) so that oscillation frequency becomes 8.222 MHz. Repeat these adjustments so that the dial readings between 144 to 148 MHz approximately correspond to oscillation frequencies of 8 to 8.222 MHz.

Step (c). Set the VFO dial to the center frequency of 146 MHz and connect the RF VTVM to G1 of V13 6AU6. Now adjust the slug of the VFO Output Coil (L15) so that maximum deflection is obtained on the VTVM.

Step (d). The oscillation frequency may shift slightly because of the above step. Therefore Step (b) should be repeated once again to make sure that frequencies are adjusted correctly.

2.2 Confirming the Oscillation of the Crystal Oscillator

Set the VFO XTAL switch to XTAL. Insert an 8 to 8.222 MHz crystal into the crystal holder and switch the SPOT Switch to ON. A check to determine whether the crystal is oscillating properly can be made by measuring the voltage at G1 of V18 6AU6 with a RF VTVM. If this voltage drops when the VFO-XTAL Switch is switched to XTAL, it indicates that the crystal is oscillating properly. The S-Meter deflections of the receiver can also be observed to make this check.

2.3 24 MHz Multiplier Adjustment

Test Equipment: DC Vacuum Tube Voltmeter.

Step (a). To protect V16 6360, cut off the B+ power

supply from its plate and screen grid. Place the VFO in operation, and turn the SPOT switch to OFF. Ground pin 4 of the Microphone Connector by shorting it to the chassis with a clip cord, and place the transmitter in operation.

Step (b). Set the DC VTVM for minus voltage measurement, and connect it across the 47 K ohm R72 on the secondary (ground side) of the 24 MHz Multiplier coil L16.

Next adjust the Piston Trimmers TC-5 and TC-6 for maximum deflection of the VTVM after setting the VFO dial to 144 MHz. Now slowly turn the VFO dial from 144 MHz to 148 MHz while noting the deflection changes of the VTVM, that is, the change in the minus grid voltages of V14 12BY7. Adjustment is correct if the plotting of the VTVM movements results in a curve such as is shown in Figure 5, (a). If, however, the frequency band width is narrow as in Figure 5, (b) or in case it is too wide, the space between the primary and secondary coils of L16 must be adjusted to obtain a curve as shown in Figure 5, (a).

This space should be narrowed if the frequency band width is too narrow, and opened up if the band width is too wide. If this space adjustment is made, Trimmers TC-5 and TC-6 must always be readjusted as explained above.

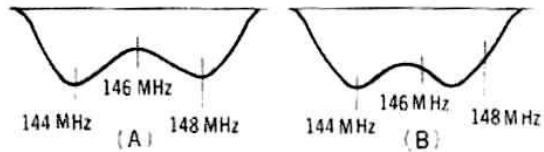

Figure 5

2.4 72 MHz Multiplier Adjustment

Test Equipment: DC VTVM, Frequency or Wave Meter.

Step (a). Connect the DC VTVM across the 47 Kohm R74 on the secondary of L17 (chassis side). Otherwise, the adjustment of this stage is accomplished in exactly the same way as outlined above for the 24 MHz Multiplier stage.

Step (b). When the band width adjustment has been completed, connect a Frequency Counter through 5PF condensers to both sides of the 47 Kohm R74. Ascertain whether frequency is 72 MHz with the VFO dial set at 144 MHz, and 74 MHz with the VFO dial at 148 MHz.

This is necessary since the frequency here is nine times that of the fundamental frequency. Thus, any discrepancy in the fundamental frequency will result in a significant frequency error here, which will necessitate adjustment. Moreover, any error here will show up twice as large in the final stage. If correction is made here, there will be no need of rechecking frequency in the final stage.

2.5 144 MHz Multiplier Adjustment

Test Equipment: DC Milliammeter (0-10 mA) or VOM Meter set to this range.

Step (a). Insert the milliammeter between the 18 Kohm R76 and the chassis, connecting the plus probe to the chassis and the minus probe to the resistor.

Step (b). Adjustment is accomplished in the same manner as for the previous multiplier stages outlined above. However, grid current is observed here, whereas grid voltage was observed in making adjustments for the previous multiplier stages.

Set the VFO dial to 144 MHz, and adjust TC-10 for maximum current flow. Now adjust TC-9 again for maximum current flow. Next, as the VFO dial is turned slowly, two peaks should be observed as shown in figure 3, the first near 144 MHz and the second near 148 MHz. See Figure 6.

The space between the coils must be adjusted so that a characteristic as shown above is achieved.

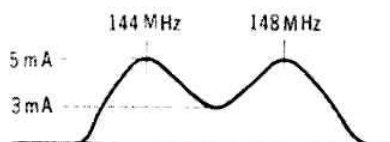

Figure 6

2.6 Adjustment of FINAL Output Circuit

Test Equipment: DC Milliammeter (0-100 mA); RF Watt meter (more than 150 MHz), 30 W.

Step (a). Connect the B+ power supply to the plate of V16 6360 and insert the Test Milliammeter into this lead. Also connect the B supply to the screen grid and place the tube in operation. Connect the RF watts meter across the ANT terminals.

Step (b). Set the VFO dial to 144 MHz; VC5 (load capacitor) in completely meshed position; and the final capacitor VC-4 in one third meshed position.

Step (c). With the unit set for transmitting operation, turn the tank capacitor VC-3 quickly and set it to the point where minimum plate current is indicated by the milliammeter.

Now turn the final variable capacitor VC-4 slowly and adjust for minimum plate current. Plate current should read about 30 mA when these adjustments are repeated. Now with VC-3 left as is, VC-5 is opened up slowly. A rise in plate current will be accompanied by a swing in the voltmeter. As VC5 is further opened up, a point will be reached where the voltage begins to drop. Set VC-5 for maximum voltage. If VC-4 is now adjusted slightly, a further upward surge in voltage will occur. In this manner, VC-4 and VC-5 should be adjusted back and forth to obtain maximum voltmeter indication.

Next adjust the VFO dial to 144.5 MHz, and adjust VC-4 and VC-5 for maximum. Now adjust TC-10 and TC-9 slightly and a further deflection will result. These two trimmers should be left set at the point where maximum deflection has been obtained.

Step (d). Output indications should be checked at 144, 145, 146, 147 and 148 MHz points, which then completes the alignment of the transmitter.

More than 9 W power output is available at 144 - 146 MHz and more than 8 watts between 146 and 148 MHz.

(Note: Plate current should not exceed 100 mA even when power output is more than 9 watts. It is necessary to pay very special attention to the adjustment of VC-3 and VC-5 which closely affects the relation between power input and power output.)

3. MODULATOR

Test Equipment: VOM Meter.

Step (a). There are no special adjustment points in the Modulator, but maximum power output cannot be achieved if the audio output tubes happen to be unbalanced. To check this, connect a VOM meter set at a low milliampere range between the two plates of V10 and V11, both 6AQ5's.

No current flow will indicate perfect balance of these tubes. If a reading of more than 0.3 mA is indicated, however, either one or the other 6AQ5 must be changed so that current flow will read less than the above figure.

4. MEASUREMENT OF MODULATION

Test Equipment: Audio Generator, Oscilloscope with direct connection to the deflection plates of its CRT.

Step (a). Insert a 1000 Hz signal from the Audio generator to the Microphone Input Jack. Connect the RF Output from the ANT Terminals through 1PF capacitors to the DIRECT input terminals of the oscilloscope. Set the transmitter in operation at 145 MHz. Confirm that 100% modulation is obtainable by observing the CRT waveform as AG output is gradually increased. (Modulation Volume Control at maximum setting).

5. DC TEST

Step (a). With the unit set for DC battery operation, connect a 12.8 V DC battery, and check whether everything operates normally.

Step (b). Check whether transmitter power output, etc. correspond with the DC Operation Specifications listed on the Specifications page of this Operating Manual.

SPECIFICATIONS

RECEIVER SECTION

1. FREQUENCY RANGE
144 - 148 MHz
2. SENSITIVITY
2 μ V at 145 MHz
S N = 10 dB
OUT = 50 mW
3. IMAGE RATIO
More than 50 dB
4. INTERMEDIATE FREQUENCIES
1st I.F. 44 - 45 MHz
2nd I.F. 10.7 MHz
3rd I.F. 455 kHz
5. NOISE LIMITER
Series-type ANL in continuous operation
6. SQUELCH SENSITIVITY
2 μ V - 300 μ V
7. SELECTIVITY
- 20 dB at \pm 10 kHz
8. AUDIO POWER OUTPUT
3 watts at 8 Ω impedance
9. ANTENNA IMPEDANCE
50 Ω unbalanced line type

TRANSMITTER SECTION

1. FREQUENCY RANGE
144 - 148 MHz
2. FINAL STAGE INPUT
20 - 24 watts
3. R.F. POWER OUTPUT
(With AC 117V power source)
More than 9 watts from 144 - 146 MHz
(With DC 12.8V battery source)
More than 8 watts from 144 - 146 MHz
4. FINAL STAGE EFFICIENCY
More than 42% from 144 - 146 MHz
5. TYPE OF CRYSTAL
FT-243
6. CRYSTAL FREQUENCY
8 - 8.222 MHz
7. VFO FREQUENCY RANGE
8 - 8.222 MHz
8. MICROPHONE INPUT
High Impedance, Push-to-Talk type.
9. MODULATION FREQUENCY CHARACTERISTIC
- 3 dB for 400 - 3000 Hz
10. ANTENNA IMPEDANCE
50 - 100 Ω

TRANSCEIVER POWER CONSUMPTION

AC117V — 106VA when receiving.
AC117V — 146VA when transmitting.
DC12V — 106VA when receiving.
DC12V — 143VA when transmitting.

TUBES & TRANSISTORS USED & THEIR FUNCTIONS:

Nuvistor:

V1 6CW4 — RF Amplifier

Tubes:

V2a 6BL8 (P) — First Mixer
V3a 6BL8 (T) — First Oscillator
V3b 6BL8 (P) — 1st Oscillator Buffer
V4 6CB6 — 2nd Mixer
V5 6BA6 — 2nd I.F. Amplifier
V6 6BE6 — 3rd Mixer, Crystal Oscillator
V7 6BA6 — 3rd I.F. Amplifier
V8 12AV6 — Microphone Speech Amplifier
V9a 12AX7 $\frac{1}{2}$ — Audio Amplifier
V9b 12AX7 $\frac{1}{2}$ — Phase Inverter
V10 6AQ5 — Audio Power Amplifier
V11 6AQ5 — Audio Power Amplifier
V12a 6AQ8 $\frac{1}{2}$ — VFO Oscillator
V12b 6AQ8 $\frac{1}{2}$ — VFO Buffer and Crystal Oscillator
V13 6AU6 — 24 MHz Frequency Multiplier (Tripler)
V14 12BY7A — 72 MHz Frequency Multiplier (Tripler)
V15 12BY7A — 144 MHz Frequency Multiplier (Doubler)
V16 6360 — Transmitter RF Power Amplifier
V17 OA2/VR - 150 — Voltage Regulator (Stabilizer)

Diode:

D1 1S72 — Multiplier (Tripler)
D2 1S72 — Detector
D3 1S72 — Noise Limiter
D4 FR - 1M — Squelch
D5 1N60 — RF rectifier for RF OUT meter
D6 FR - 1K — Power Supply High Voltage Rectifier
D7 FR - 1K — Power Supply High Voltage Rectifier
D8 FR - 1M — Relay Voltage Rectifier

Power Transistor:

Q1 - Q4 2SB337 — D.C. - D.C. Converter

DIMENSIONS:

6 $\frac{5}{8}$ " H, 11 $\frac{7}{8}$ " W, 12 $\frac{3}{4}$ " D.
Not including protruding parts with the exception of legs.

WEIGHT:

22.2 lbs.

BUILT-IN CIRCUITS:

S-Meter, RF OUT Meter
Calibrator
Squelch
Automatic Noise Limiter

SCHEMATIC DIAGRAM

